



International Machine Tool &  
Manufacturing Technology Exhibition

**JANUARY 19 - 25, 2023, BANGALORE, INDIA**

CONCURRENT SHOWS



International Exhibition of Cutting Tools, Tooling Systems,  
Machine Tool Accessories, Metrology & CAD / CAM



International Exhibition on  
Industry 4.0 & Additive Manufacturing

1946 - 2021



**SHOWDAILY™**

*The official Show Daily of IMTEX 2023*

DAY 1 • THURSDAY, JANUARY 19, 2023

# Mazak

**GLOBAL LEADER IN MACHINE TOOLS**

[www.mazakindia.in](http://www.mazakindia.in)



VC-EZ 410 IP



VC-EZ 510 IP

## LARGEST MACHINING AREA FOR VMC MACHINES

- High-speed automatic tool changer
- ATC auto-recovery
- Large axis strokes
- High-accuracy machining with heat displacement control
- Enhanced cutting performance
- Ergonomics machine design
- Large opening door
- Ez tool loading in spindle
- High-performance lubrication system
- Easy maintenance
- User-friendly and excellent operability

# Accelerate digitalization in machine tool manufacturing

Visit us at Hall 4, Booth B144 and make your digital transformation a reality

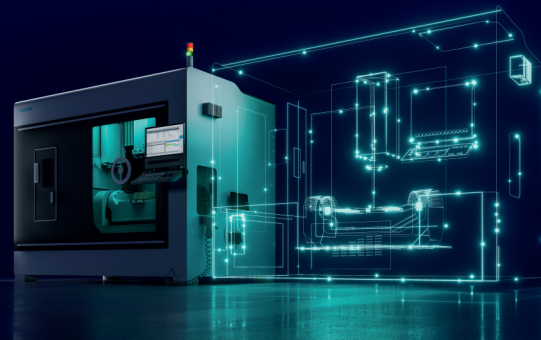

RISING UP

## Towards the Next Phase of Growth

Organized by Indian Machine Tool Manufacturers' Association (IMTMA), the much-anticipated IMTEX, South Asia's apex international machine tool and manufacturing technology exhibition, is back stronger. The show, with its concurrent shows Tooltech and Digital Manufacturing, will be celebrating two major causes – India's achieving global recognition in the manufacturing arena and IMTMA's completing 75 glorious years of striving relentlessly in this pursuit.



Source: IMTMA

MTEX 2023 & Tooltech 2023 and Digital Manufacturing is all set to bring together the Indian Machine Tool industry players to showcase their mettle to the world and declare that India has finally arrived. The popular trade fair, which starts today and will continue until January 25, 2023, is covering an exhibition space of approx. 77,000 sqm in

5 halls of Bangalore International Exhibition Center (BIEC), Bengaluru, hosting 981 exhibitors from 23 countries that represent every aspect of traditional and modern manufacturing. IMTEX 2023 has companies displaying turning, drilling, boring, grinding, milling, tool grinding, and gear cutting machines; CNCs; flexible manufacturing systems; honing, lapping, polishing, and deburring

machines; robotics and manufacturing automation, and many more. Concurrent to IMTEX 2023 is Tooltech 2023, showcasing machine tool accessories, metrology and CAD/CAM cutting tools, tooling systems, and current trends in the Tooling industry. 3D Printing, sensors, robotics, soft-

To be continued on 4 ▶



SmartFix4.0<sup>®</sup>  
Intelligent Fixtures



Winner of CII Industrial Innovation Award 2020

- Tool Wear Analytics
- Cost Per Component Analytics
- Vibration Alerts
- Declamp Alerts
- Output of Fixture and Machine
- Predictive Maintenance of Fixture and Machine
- Analytics of Operator Efficiency
- Historical Analysis of performance of machine, powerpack, tools and fixture
- Powerpack oil level and oil contamination alerts

Smartfix 4.0 can be installed on existing fixtures also and is the most cost effective way of making the entire machining set up Industry 4.0 enabled.

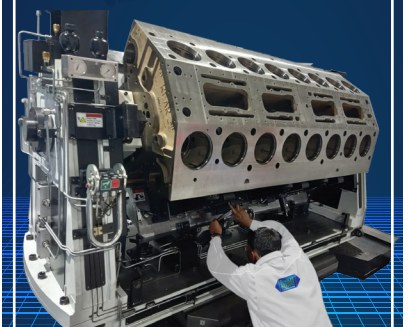

Asia's leading fixture builder

For over 50 years Forms & Gears has been supplying Precision Fixtures to the world's leading Auto OEMs and Machine Makers in 10 countries across the globe.

RV Forms & Gears LLP  
MF 11, SIDCO Industrial Estate, Guindy,  
Chennai - 600 032, Tamilnadu, India  
Call +91 77570 53326 or email us on  
marketing@rvformsandgears.com  
www.rvformsandgears.com



## Helping aircraft get off the ground. Together.

Hall No-5 Booth No: B 121  
quakerhoughton.com | info@quakerhoughton.com





» IMTEX is one of the world's important trade fairs for the Machine Tool industry as it provides a platform to present innovations, cultivate contacts, and drive business goals. The manufacturing community can leverage the platform of IMTEX 2023 & Tooltech 2023 and Digital Manufacturing 2023 to get acquainted with the latest technology trends and high-value products and set the ball rolling for enhanced manufacturing growth.«

**Ravi Raghavan**  
President  
IMTMA



» IMTEX 2023 can be the harbinger of the transition in core manufacturing sectors as well as sunrise sectors and possibly accelerate the adoption of new age technologies in manufacturing. The exhibition is a platform for two-way traffic in the form of negotiations and bargaining on technologies. In India, foreign investors can receive significant FDI and by participating in IMTEX, they can acquaint themselves with Indian market conditions.«

**Jibak Dasgupta**  
Director General & CEO  
IMTMA

ware, and cobots are on display at Digital Manufacturing 2023.

### Leaders' take

Jibak Dasgupta, Director General & CEO, IMTMA, is highly optimistic about the event, which is making a comeback after a span of four years. "IMTEX 2023 can be the harbinger of the transition in core manufacturing sectors as well as sunrise sectors and possibly accelerate the adoption of new age technologies in manufacturing. The exhibition is a platform for two-way traffic in the form of negotiations and bargaining on technologies. In India, foreign investors can receive significant FDI and by participating in IMTEX, they can acquaint themselves with the Indian market conditions," he notes.

### A comprehensive show

IMTEX holds the reputation of being an all-around industrial event and IMTMA endeavors to spare no effort in ensuring that. The following are the programs that have been included in IMTEX 2023.

**International Seminar on Manufacturing Technologies:** The seminar happened yesterday and explored global manufacturing trends in Machining, Emerging Trends, Additive Manufacturing, Workholding and

Tooling, Enabling Technologies, and Industry 4.0 through parallel concurrent sessions.

### International Buyer Seller Meet:

Under the aegis of the Ministry of Commerce and Industry, Government of India, IMTMA, in collaboration with Engineering Export Promotion Council (EEPC) of India, is organizing the International Buyer Seller Meet 2023 on January 23 and 24, inviting potential buyers of machine tools from target overseas markets to explore mutual business opportunities between the Indian machine tool and accessories manufacturers.

**IMTMA Export Performance Award:** The award will be presented to companies that have made notable achievements in the export of machine tools and related products manufactured in India.

### IMTMA Best Design Award 2023:

IMTMA has initiated the 'IMTMA Best Design Award' to recognize and honor enterprises for their excellent indigenously designed, developed, and manufactured products in metal cutting technology. Technology, Design, Innovation, Functionality, Energy Efficiency features, Safety features, Import Substitution (AatmaNirbhar Bharat), and Unique Selling Proposition, among others, will be evaluated.

### CONNECT – A Unique Forum for Next Generation Engineers:

One of the extra attractions at IMTEX is 'CONNECT' where engineering students from mechanical and electrical streams, among others, can meet, network, and explore prospects in various machine tool and manufacturing industries. CONNECT is meant to be a medium for recruiting companies to connect with industry aspirants, present their company profile, technology, and current job requirements, and interview them.

Engineers can also display their capabilities, talents, and competitiveness.

**Industry-Institute (i2) Academia Pavilion:** It is an opportunity for

the participating 22 top universities, including IITs, to display their R&D capabilities in the metalworking arena to the world.

**Jagruti:** This special initiative on January 21-22 is one in which students attending IMTEX will be guided around the exhibition (including visits to the IMTMA Technology Centre) and students from various engineering universities will take part in the 15<sup>th</sup> Jagruti - IMTMA Youth Programme as well.

**Live Demo:** A real-time working model of 'Industry 4.0 in Manufacturing' will be shown at the IMTMA Technology Centre from January 20-25, 2023.

SD

**India's only**  
**Authorised Service Centre for**  
**Weiss - Siemens and Kessler Spindles**

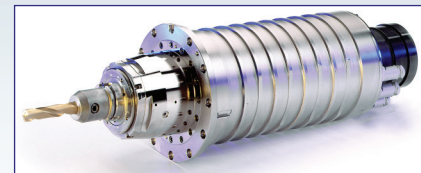

**Your Trusted Partner**

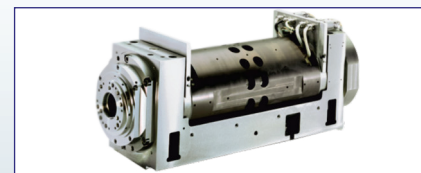
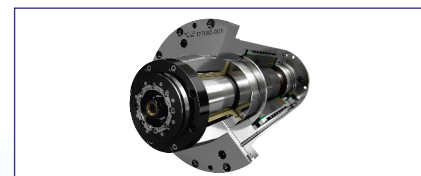

**We Repair & Service all makes of Servo and Spindle Motors**

Bangalore - santoshpattar@rajamane.com Mobile No: 9900592261

Tumkur - rhp.tmk@rajamane.com Mobile No: 9900551455

Pune - rhp.pune@rajamane.com Mobile No: 8007819988



[www.rajamanehegde.com](http://www.rajamanehegde.com)



[www.rhpul.com](http://www.rhpul.com)



# BUILT FOR EFFICIENCY & PRECISION

## EXCETEK NP500L

High Precision CNC Wire EDM  
with Linear Motor

NP 500L CNC Wire EDM features High Precision and Superior Surface Finish It is tailor-made for die and mould application, press tools and precision parts manufacturing

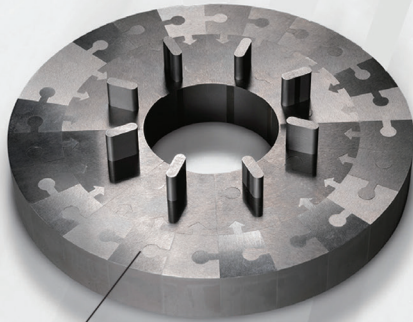

Workpiece: SKD-11  
Thickness: 20 mm  
No. of cut: 1 rough cut + 2 trim cut

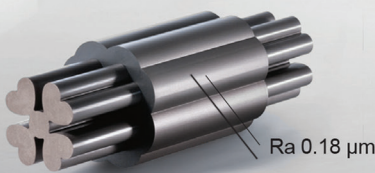

Workpiece: Tungsten carbide  
Wire: 0.2 mm / Brass  
Thickness: 50 mm  
No. of cut: 1 rough cut + 4 trim cut



**EXCLUSIVE  
DISTRIBUTOR  
\*INDIA\***

### FEATURES & BENEFITS

#### Advanced High-Thrust Linear Motor

Advanced High-Thrust Linear Motors and scales with direct feedback provides smooth, vibration-free table movement, which ensures improved positioning and cutting accuracy. Compared to ball-screws backlash, lost motion and wear issues are eliminated, assuring long-term high precision performance.

#### Reliable Auto Wire Threading system

The EXCETEK AWT is very sophisticated design that provides continuous unmanned operation day and night. Unlike other systems it can thread at the point of wire breakage. A water jet function enables the machine to thread workpieces up to 400mm.

#### Power Generator System

##### Discharge Frequency and Control

- The generator is designed to reduce system load and stabilize cutting conditions.
- ASIC chip technology is used to increase circuit stability and discharge performance.
- Real-time feedback of the discharge and cutting status is monitored and adjusted to reach optimum speed and accuracy.



**250+**  
INSTALLATIONS  
Across India



Corporate Office

### S&T ENGINEERS (P) LTD.

22, Vasanth Nagar, Singanallur,  
Coimbatore - 641 005, Tamil Nadu, India.

- ☎ +91-422-2590810, 2591470, 2593487
- ✉ +91 98423 04318 ✉ info@stengineers.com
- 🌐 www.stengineers.com



**STALL :** A113 - Hall 1A  
**DATE :** 19<sup>th</sup> - 25<sup>th</sup> Jan - 2023  
**TIME :** 10.00 am - 6.00 pm



**S&T  
GROUP**  
SINCE 1996

**MAKING TECHNOLOGY  
AFFORDABLE**

**KNOWLEDGE SHARING**

# Breaking New Grounds

The International Seminar on Machining Technologies (ISMT), organized by IMTMA on January 18, 2023, a day before the start of IMTEX 2023 & Tooltech 2023 and Digital Manufacturing, highlighted the evolving trends in manufacturing technologies.



Source: IMTMA

(L-R): Rajendra Rajamane, Vice President, IMTMA; Guest of Honor of the Seminar Dr Nandini Chakraborti, Associate Director, Manufacturing Technology Centre, UK; Ravi Raghavan, President, IMTMA; and Jibak Dasgupta, Director General & CEO, IMTMA

## Insightful sessions

Dr Nandini Chakraborti, Associate Director, Manufacturing Technology Centre, UK, was the Guest of Honour of the Seminar who spoke

on 'Accelerating the Adoption of Industrial Digital Technologies in Manufacturing' at the inaugural session. Renowned international companies and research institutes,

as well as representatives from India, offered their experiences and the most recent breakthroughs in manufacturing technologies.

The Seminar was spread over three concurrent sessions and six technology tracks including Machining, Emerging Trends, Additive Manufacturing, Workholding and Tooling, Enabling Technologies, and Industry 4.0.

Specialists and experts from global companies took up topics that needed to be spoken about. WFL Millturn Technologies, Austria spoke on 'Machining', covering Titanium and Inconel machining for large-size jobs. 'Special features for 5-axis machining' was the chosen subject by Makino, Japan. DMG Mori, Germany talked about 'Integration of technology with machining: Booster for efficiency'. In 'Emerging Trends' by Zetwerk, India, key topics were Digitization and New Age Approach to On Demand Manufacturing. Applications of Metaverse in manufacturing were discussed by Bosch, India. IIT, Madras presented their take on Performance analysis and evaluation of the sustainability

of a machining system. In 'Additive Manufacturing' it was Solutions in a virtual 3D printing environment by Hexagon, India. Amace Solutions, India spoke on what it does best, which is 'Operating economics for metal Additive Manufacturing'. 'Rapid adoption of Additive Manufacturing in the Space sector' was spoken about by Manufacturing Technology Centre, UK.

Schunk, Germany featured Intelligent workholding solutions in 'Workholding and Tooling'. IIT, Kanpur suggested ways to 'Make special roughing and variable geometry cutters better'. ISCAR, Israel highlighted 'enhancing tooling productivity by better design'. 'Enabling Technologies' by Blum Novotest, Germany, encompassed topics such as Laser tool profile measurement at CNC machine. Siemens, Germany; Marposs, Italy; Association for Manufacturing Technology, USA; m2nxt, India; and Fanuc, India, were other presenters who threw light on the emerging trends in manufacturing that are still lesser-known and deserve to be spoken about.

SD

**ZAVENIR DAUBERT** **IMTEX 2023**

we keep your metal healthy



19 - 25 Jan 2023

Visit us at  
**HALL 4 BOOTH A 154**

**C** Cut with X-CUT

**P** Protect with NOX-RUST

**C** Clean with X-CLEAN

**P** Pack with DAUBERT VCI

**BUILDING BIGGER BUILDING BETTER**

FOLLOW US ON [f](#) [t](#) [in](#)

WWW.ZAVENIR.COM [+91 124 4331000](tel:+911244331000) [MARKETING@ZAVENIR.COM](mailto:MARKETING@ZAVENIR.COM)

## DRILL TAP CENTERS

# For High Speed and Highest Productivity

**S**TM VD 510 High-Speed and High-Productivity Drill Tap Center is a compact multi-tasking speedo machine used for machining Automotive parts, Electronic parts, and Aerospace parts for mass production. The machine comes with a highly rigid structure, highly efficient spindle, the latest CNC controller, fast and precise ATC, which ensures the machining of complex parts with the lowest cycle time. It offers the lowest tool changing time (1.5 Sec), high spindle rpm (up to 20000), compact footprint, the highest rapids (48/48/60 m/min), resulting in lowering the non-productive time and justifying the speed and productivity for a broad range of complex parts.



Source: S&T Machinery (P) Ltd

**S&T Machinery (P) Ltd**  
www.stmcnc.com  
Hall & Stall: 1A/A-117

Options of 4<sup>th</sup> & 5<sup>th</sup> axis, fixtures, and complete tooling up prove out solutions are available to give the best output possible.

SD

— **NEW GENERATION** —  
**CNC Rotary  
Tables**

INTRODUCING A NEW RANGE

**Q SERIES**

**Compact · Superior · Reliable**

The answer to your quest for excellence!

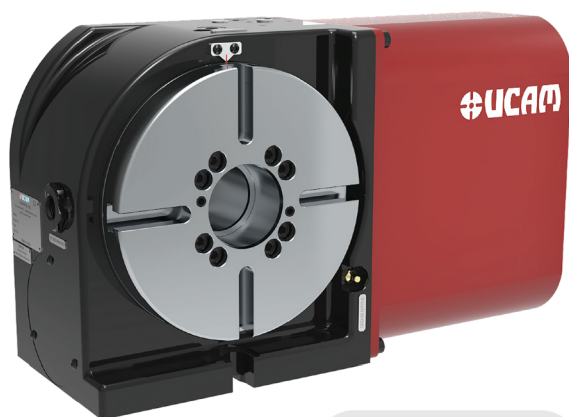

URQ200



USSRQ200



Please visit us at  
**Stall No. A102,**  
**Hall No. H1A**



Scan this code  
or log on to [ucamind.com](http://ucamind.com)

A-11 / 12, 1st Stage, 1st Cross, Peenya Industrial  
Area, Bengaluru - 560 058, INDIA

**Something  
NEW  
Something  
BIG**  
is on its way!

Hall No. 4 | Booth B 135

WE LOVE TECHNOLOGY

**FIBRO**  
INDIA



**IMTEX 2023**



Standard parts for Die & Mould Making

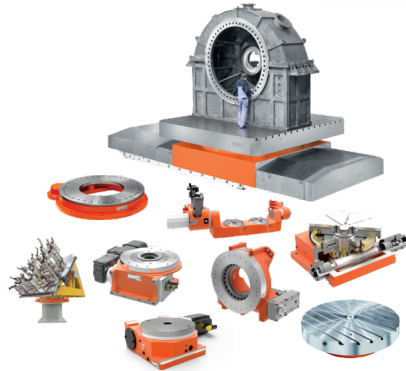

Rotary Tables for Machine Tools & Automation Systems



Protection System, Vision System, Clamping & Braking System required for Machine tool OEMs



LinkedIn

**FOLLOW  
US FOR  
UPDATES**

**FIXTURE SOLUTIONS**

**Engineering Services from Forms and Gears**

**Forms and Gears is offering its vast client base in India and abroad Engineering Services in areas like Mechanical Design, Simulation, Electrical & Electronics, Software, Fixture design, and SmartFix-lot.**

Forms and Gears is leveraging the expertise of its joint venture partner ASM Technologies, which employs 1,400 engineers across the globe, to offer its clients Engineering services in areas like Mechanical Design, Simulation, Electrical & Electronics, Software, Fixture design, and SmartFix-lot. The Design Automotive vertical works with customers and complements their Product Engineering efforts by accelerating the adoption of new-age digital technologies, providing competencies and talent at scale, and leveraging best practices from various OEMs and TIER 1s. Computer Aided Engineering services offer cost-effective measures, which make the designs feasible, enhancing productivity completely.

In the product development cycle, with products getting smarter, connected, and more efficient by the day, and innovation cycles getting shorter, the ASM Group helps clients in finding the right solutions for new product design and improving legacy products.

**Together in growth**

The company will partner with clients in their digital initiatives with their extensive domain knowledge and engineering expertise help drive business outcomes. These services are also being rolled out to clients new Pune office. **SD**

**RV Forms and Gears**  
www.rvformsandgears.com  
www.formsandgears.com  
Hall & Stall: 1B/B-108

**TOOL GRINDING MACHINES**

**Bringing Maximum Flexibility**

Whether producing or re-grinding, whether as a cost-effective basic machine or as a fully automated tool grinding machine: the new HELITRONIC MINI PLUS tool grinding machine from WALTER can and is all that. The extraordinary flexibility is the unique WALTER gantry design. The economical production of common and complex geometries and diameters from 1 to 16 mm in one clamping is guaranteed by the powerful HSK belt spindle with two spindle ends for up to six grinding wheels (as standard).

'increase' option is available which increases torque and removal rate by up to 60 percent, thus guaranteeing maximum productivity. The top loader integrated into the workspace is a space-saving and cost-effective automation solution. Depending on the tool diameter, it offers up to 500 tool locations. Via the robot loader, up to 7,500 tools can be loaded depending on the type of tools or tool diameter. The maximum tool weight is 5 kg, and the maximum diameter is 125 mm. **SD**

**Numerous options for more efficiency**

WALTER offers a wide range of options for the HELITRONIC MINI PLUS for application-specific configuration such as an automatic grinding wheel changer for up to six grinding wheel holders (maximum diameter 152.4 mm) including coolant supply lines, which ensures a safe wheel set change and offers maximum flexibility. A 'torque



**United Grinding India LLP**  
www.grinding.ch  
Hall & Stall: 4/C-115





We invite you for a live demo

Hall : 5 Stall No. : B 107



## Line up of India's finest range of CNC machines



**STURN - I**  
The Next Generation Turning Center



**GIGATURN - I**  
Large Diameter Turning Center



**J8**  
Vertical Machining Center with  
BT50 Toolings



**J6 R**  
Vertical Machining Center with  
Rotary Pallet changer



**JH500**  
New Generation Horizontal  
Machining Center

TURNING MILLING TURNMILL



**LAKSHMI MACHINE WORKS LIMITED**  
MACHINE TOOL DIVISION

Arasur, Coimbatore - 641 407, Tamil Nadu, India.  
Tel: +91 422 719 1393 / 94 / 95 / 96 / 97  
Email: [mtd\\_marketing@lmw.co.in](mailto:mtd_marketing@lmw.co.in)  
[www.lmwcnc.com](http://www.lmwcnc.com)

**LAUNCH - TURNING CENTERS**

# The Next-Gen S Turn 1



Source: Lakshmi Machine Works Ltd

**Lakshmi Machine Works Ltd**  
www.lmwcnc.com  
Hall & Stall: 5/B-107

Lakshmi Machine Works Ltd has launched a next-gen and contemporary turning center at IMTEX 2023 & Tooltech 2023 and Digital Manufacturing 2023. The state-of-the-art turning machine has a maximum turning dia of 320 mm and a maximum turning length of 400 mm. The machine comes with an 8-station hydraulic turret, a spindle speed of 4500 rpm, and a spindle power of 5.5/7.5 kW. It

has been interfaced with gantry automation. High-speed positioning keeps non-cut time to a minimum. The machine is suitable for Aerospace, Automobile, Defence, Die & Mould, Pumps & Valves, and General Engineering industries. All the company's machines are IOT-ready. On the operations side, it has introduced a new customer portal for online sales of spare parts (e-commerce) and mobile apps for customer connect. The entire service operation is digital or simply paperless. The company has established a pan-India network of sales and services that caters to every industrial city in India. The Machine Tool division provides integrated solutions for various industrial needs in Automobile, Aerospace, Die & Mould, Defence, Pumps & Valves, Railways, Medical Equipment, Forging, and General Engineering industries. LMW also provides automation solutions such as simple Loaders, Gantry systems, and Robots that are tailored to meet customer requirements. **SD**

## Filtration at its compact best

More filtration per square inch



**COMPACTO**  
COMPACT BAND FILTER

Compact Band Filters are engineered to improve the performance and efficiency bandwidth. Combining superior filtration technology and diverse capacities in a compact solution, Compacto brings global standards to the workforce.

Visit us at our Stall No. B120 (Hall-5)



Scan to download company profile and catalogues



'U-Tech House', # 33/1, Malathalli Main Road, Malathalli Post, Bangalore - 560 056.  
Ph: +91 80 2318 2828  
Email: sales@u-techindia.com www.u-techindia.com

**INTERNATIONAL ASSOCIATION: JMTBA**

# Fuelling the Growth

**Kazuo Yuhara, President, Japan Machine Tool Builders' Association (JMTBA), believes IMTEX 2023 is a big opportunity for witnessing automation solutions such as IoT, AI, and DX (digital transformation).**

Kazuo Yuhara, President, JMTBA, is of the view that IMTEX 2023 is a not-to-be-missed opportunity for machine tool manufacturers whose main customer is the automobile industry, which is facing a turning point worldwide.

Source: JMTBA



"Currently, efforts toward smart manufacturing using IoT, AI, and DX (digital transformation) are evolving, and the trend toward visualization of manufacturing sites and automation of each process from design to production is accelerating. For example, we use many sensors to analyze the behavior of the machine tool itself and the machining process, feedback information, and work to optimize machining, as well as enrich the IoT platform and collaborate with robots. It is expected that IMTEX will be able to see automated solutions such as this," he adds.

### Solidifying Indo-Japan bonds

Twenty-six JMTBA member companies and some other Japanese companies are exhibiting at IMTEX 2023. "JMTBA members are presenting highly versatile multi-axis, multi-tasking, and high-precision machines, etc., in order to respond to the development of the Indian manufacturing industry. In this way, we intend to contribute to the growth of the Indian manufacturing industry," points out Yuhara.

He offers statistical data: the export value of machine tools from Japan to India was 28,270 million yen in 2021 (up 10.2% year-on-year) and 27,304 million yen in 2022 (January-October period) (up 5.6% year-on-year). Whereas, the import value from India to Japan was 63 million yen in 2021 (up 221.2% year-on-year) and 11 million yen in 2022 (January-October period) (down 81.1% year-on-year).

» The Indian Government, which advocates 'Independent India', is actively promoting the domestic manufacturing industry and attracting factories from overseas. Thus India's manufacturing industry has high potential.«

**Kazuo Yuhara**  
President  
Japan Machine Tool Builders' Association (JMTBA)

He elaborates on the various technologies from Japan that can help the Indian manufacturing sector. These include: Technologies related to automated production systems that utilize DX, IoT, and AI to link machine tools and robots, etc.; Environment-friendly technologies to achieve carbon neutrality; Development of additive manufacturing in practical use; and Evolution of compound/5-axis machining. **SD**

**Japan Machine Tool Builders' Association (JMTBA)**  
www.jmtba.or.jp  
Hall & Stall: 1B/C-101



## Achieve toolholding excellence

visit REGO-FIX Booth No C110 ,Hall 3A to witness fastest Tool Clamping in the world with 5 years warranty

**NEAT CUTTING OILS**

# X-CUT<sup>®</sup> from Zavenir Daubert

**X**-CUT<sup>®</sup> Neat Cutting Oils are used in various machining operations like grinding, turning, milling, broaching, drilling, tapping, and gear cutting to provide cooling and lubrication. X-CUT<sup>®</sup> Neat Cutting Oils are made from Group II base oils. These are hydro-processed base oils with high purity and 99 percent saturates. In a three-stage process, these base oils are hydrocracked at a very high pressure to restructure aromatic compounds with hydrogen into saturates and remove sulfur. Next, catalytic dewaxing (hydro-isomerization) improves saturation to create more Isoparaffins. Lastly, at low temperatures and high pressures the remaining aromatics are also saturated. The use of these hydrocracked group II base oils provides the basis of X-CUT<sup>®</sup> Neat Cutting Oils with superior anti-oxidation properties, anti-wear properties, and reduced evaporation and misting losses. Chlorine-free extreme pressure additives provide excellent tool life

without compromising the environmental norms and risks associated with conventional chlorinated oils.

**Benefits**

- Chlorine-free – Higher productivity with environment-friendly formulations;
- Group II base oils – Lower consumption, lower evaporation, and misting losses;
- Multi-function and multi-metal compatibility – Low inventory costs and ease of logistics. **SD**

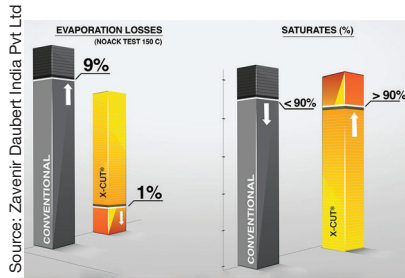

**Zavenir Daubert India Pvt Ltd**  
www.zavenir.com  
Hall & Stall: 4/A-154

Source: Zavenir Daubert India Pvt Ltd

**TOOL HOLDERS**

# Eppinger Tool Holders

**E**ppinger Tool Holders are available in a wide range, based on machine and application. The company offers Tool Holders—Static and Driven/Live. These Tool Holders are available in BMT and VDI versions and are high-precision, high-rigidity. The Tool Holders are of monoblock design i.e. one-piece cage design which provides better rigidity and stability. The use of a taper roller double bearing ensures the tool holder can withstand higher cutting torques. Eppinger's patented Compensation Clutch for the interface tenon offers many advantages to the user like reduction in backlash, no misalignments, minimization of radial force against the bearing system, no vibrations, and reduction in temperature and noise. With these advantages, the user gets higher productivity with reduced downtime. The 4-key design technology makes mounting of the tool holder on the turret very easy. The PRECI-FLEX<sup>®</sup> adapter system, a revolutionary tooling system first introduced by Eppinger, provides

flexibility to use any type of adapter in all its live tool holders. The interchange system makes lathe tooling changeovers quick, accurate, and economical. The company's highly precise repeatability is unsurpassed. A conical and flat-face planar interface ensures the highest accuracy and rigidity. It's practical and simple to use. Collets, endmill holders, expanding collet chucks, and shrink-fit tooling, to name just a few, can all be mounted on a single base holder. Interchanging pre-set tools reduce expensive machine downtime to almost nothing.



**Eppinger Tooling Asia Pvt Ltd/ESA Eppinger GmbH**  
www.eppinger.de  
Hall & Stall: 2B/B-101

Source: Eppinger Tooling Asia Pvt Ltd/ESA Eppinger GmbH

# PIIT MACHINES LIMITED

Pune & Halol

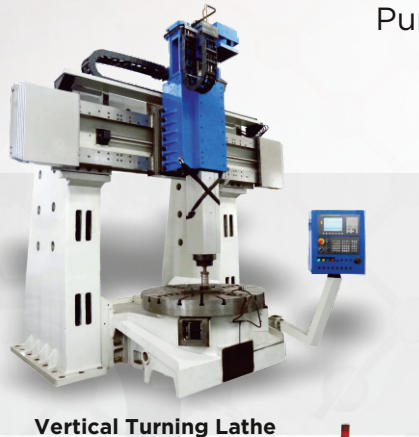

**VISIT OUR STAND AT HALL No. 2A  
STALL NO. B 112**



THE C.O.R.E. DIFFERENCE

# MEET A TRANSFORMATIONAL MACHINE OPERATING SYSTEM.

Hall 4,  
Booth C115



Brilliant operating systems have a way of making work easier. That's what the Customer Oriented REvolution (C.O.R.E.) delivers. Now available on the most popular UNITED GRINDING machine models, it's an intuitive, user-friendly and efficient way to bring intelligence and profitability to your CNC grinding. **Learn more about it at booth C115.**



MÄGERLE | BLOHM | JUNG | STUDER | SCHAUDT | MIKROSA | WALTER | EWAG

**CASE STUDY**

# Achieving Productivity and Profitability



Source: Blaser Swisslube Solutions Pvt Ltd

» JKS achieved significant improvement in the sump life, coolant stability, tool life with even overall cost-per-component savings.«

**S Jayakumar**  
Managing Director  
JKS Precision Engineering Pvt Ltd

**J**KS Precision Engineering Pvt Ltd, established in 2012, is a manufacturer of CNC precision components for Valve, Aerospace, and Medical industry as well as General Engineering. It has state-of-the-art machines, including

HMC, VMC, CNC, and CNC automates and is equipped with 36 CNC machines and CMM. It is specialized in machining Stainless steel, Inconel, Titanium, etc. S Jayakumar, Managing Director, JKS Precision Engineering, has expertise in making

in-house design and manufacturing of jigs and fixtures.

The company was experiencing coolant challenges like smell, foam, and operator skin itching. With this in mind, a meeting was set up with the expert team from Blaser. A detailed on-site analysis was carried out. The goals were well defined, such as sump life improvement, coolant stability, tool life improvement, and fewer breakdowns.

ble for precision cleaning due to outstanding rinse behavior and easy cleanability. It shows excellent tramp oil separation and filterability down to 1 micron.

It is known for its exceptional lubrication properties which help to reduce friction and heat generated during the machining process, resulting in longer tool life and improved surface quality. The product also contains corrosion inhibitors to protect the machine parts and the workpiece from corrosion.

The metalworking fluid exhibits performance in a variety of materials including aluminum and titanium alloys, steel and stainless steels, composites (CFRP and others), and is designed for use in DI/RO or otherwise demineralized water.

## Advantages galore

Blaser suggested Synergy 735, which is a crystal-clear, water-miscible, and oil-free metalworking fluid designed for use in metalworking operations such as turning, milling, drilling, and grinding. Since it is transparent, the coolant gives a clear view of the machining process. It has a neutral odor and excellent skin compatibility. It is free of critical substances such as bactericide, boron, and formaldehyde, sulfur, and chlorine, making it safe for humans and the environment. Extremely low foaming makes it ideal for high-pressure systems. It is without chlorinated EP additives. The fluid leads to spotless surfaces, thanks to neutral pH, even with sensitive aluminum alloys. It is suitable

## Saving optimization

The results at JKS were overwhelming with the high-performance Synergy 735. JKS achieved significant improvement in the sump life, coolant stability, tool life with even overall cost-per-component savings. The implementation of a robust coolant monitoring system brought smiles to the faces of the team at JKS Precision Engineering. This optimization achieved an annual saving of ₹20 lakh for its 36 CNC machines.



**Company Name:** JKS Precision Engineering Pvt Ltd

**Award Category:** Metalworking Fluid Optimization

**Industry:** Oil & Gas

**Production:** Valves components, Aerospace components, Medical components

**Application:** Milling, Drilling, Reaming, Tapping

**Material:** Stainless Steel

**Objective:** To optimize coolant stability and sump life as well as improve tool life. The company was experiencing coolant challenges like smell, foam, and operator skin itching.

**Solution:** Coolant Synergy 735  
JKS achieved significant improvement in the sump life, coolant stability, and tool life with even overall cost-per-component savings.

**Blaser Technical Consultant:** M Murali



Source: Blaser Swisslube Solutions Pvt Ltd



**Blaser Swisslube Solutions Pvt Ltd**  
www.blaser.com  
Hall & Stall: 1B/A-111

Source: Blaser Swisslube Solutions Pvt Ltd

## We help you win – now and in the future.

Decades of machining experience have taught us there are complex correlations between chemistry and mechanics. Profit from our knowledge to optimize your processes, keep them stable and quickly resolve issues.

**Meet us at our booth A111 in hall 1B.  
It's worth it.**





## TOTAL SOLUTIONS FOR CARBIDE ROD CUTTING

**Hall: 1A, Stall: A101**

Guhring, Cerazit, Wolf...  
More than 50 installations across the world.



**Chennai Metco**  
[www.chennaimetco.com](http://www.chennaimetco.com)

**MILLING CUTTERS**

## Metal Cutting Solutions for Aerospace

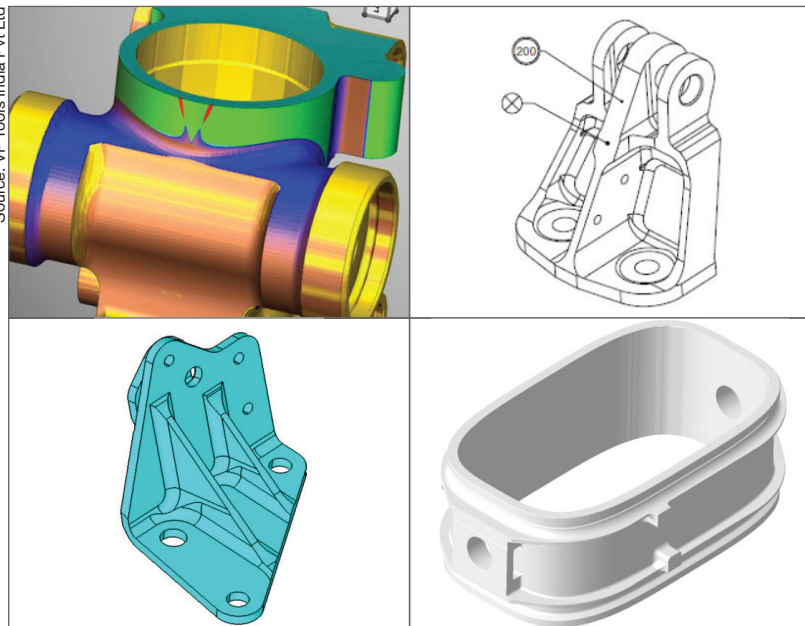

VP Tools has vast experience in providing Metal Cutting Solutions for the Aerospace industry in India. Here are some of the optimized solutions for a typical 5-axis machining setting, a benchmark that is at par with international brands. The company's solid carbide High-Feed Milling Cutters are the best solution for roughing and semi-finishing of super alloys like 15-5 PH Steel with a feed rate of 4.5 m per min and stability in the machining process with a tool life of up to 750 min. Optimized Corner radius endmills are for cavity milling of material grade Inconel 718 with high MRR

and longer tool life. MRR achieved is 6.2 cm<sup>3</sup>/min with a tool life of more than 120 min. Unique Hard Part Endmills are for rough to semi-finish milling of Titanium Ti-6Al-4V. Trochoidal milling with 32 mm depth per pass with tool life of more than 350 min. High Helix Finish End Milling Cutters are best suitable for finishing Deep Cavity Walls (Inconel 718), maintaining perpendicularity of 0.015 over 115 mm, higher surface finish, and tool life of up to 150 min. **SD**

**VP Tools India Pvt Ltd**  
[www.vptools.in](http://www.vptools.in)  
Hall & Stall: 4/B-146

**LASER GEAR INSPECTION SYSTEMS**

## Marposs' New Laser Profiler



Marposs, a global leader in measurement, inspection, and test technologies, has announced the launch of its new laser profiler for gear inspection, which uses laser profile sensors and the optical triangulation principle. The use of laser technology in the profiler allows it to easily adapt to inspect a variety of gear sizes and shapes in a very short time. Laser profilers project a laser line onto the gear at a specific angle, collecting data to generate the complete Z-X profile through an image sensor behind the optical receiver. The gear is then quickly rotated 360° to collect data points from the movement along the Y-axis, which are combined with the Z-X profile to create a complete 3D reconstruction of the part, enabled by specific software algorithms. The system then performs the requested measurement and inspection

tasks. Line operators can easily review the images and navigate to the desired level of detail to identify any anomalies. The Laser Profiler can inspect helical and spur gears, odd and even toothed, with outside diameters of 30 ÷ 300 mm and heights of 15 ÷ 40 mm. It can measure features with tolerances down to 5-10 µm. With a cycle time of about 40 seconds, it can accurately inspect micro-geometric features. The non-contact system can be interfaced with Marposs electronic measurement display units, such as the powerful E9066 industrial computer with a sophisticated graphical display algorithm for gear analysis as well as comprehensive statistical calculations. **SD**

**Marposs India Pvt Ltd**  
[www.marposs.com](http://www.marposs.com)  
Hall & Stall: 3A/B-101

Source: VP Tools India Pvt Ltd

Source: Marposs India Pvt Ltd



# TWO IS BETTER THAN ONE

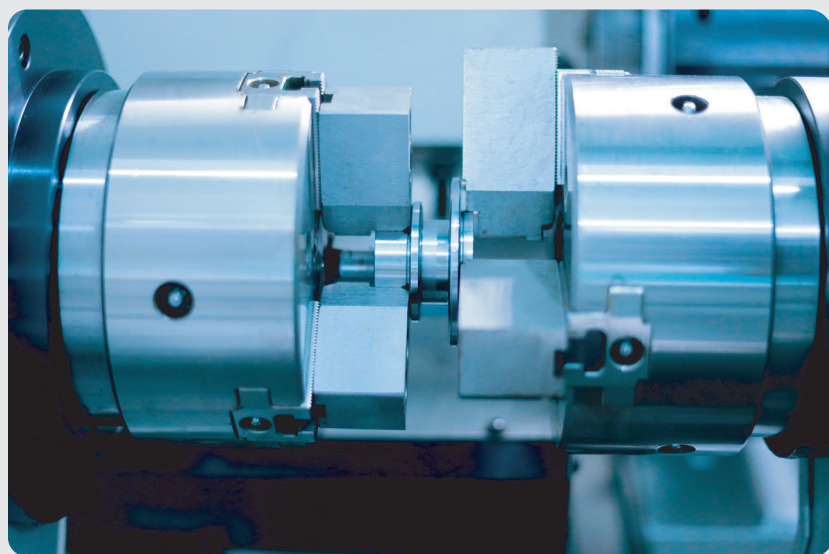

**ON THE FLY TRANSFER**

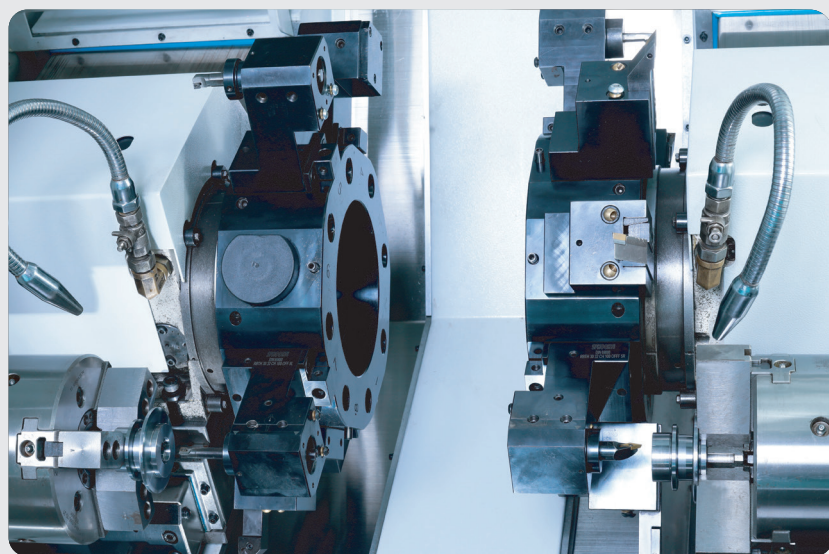

**SIMULTANEOUS MACHINING**

Launching  
**DUO SERIES SUB SPINDLE MACHINES**  
with Single Turret and Twin Turrets capabilities

Meet us at  **IMTEX 2023** Hall: 1A Stall: B105

to experience our state-of-the-art Sub Spindle Series of machines.

INDIA'S NO.1 EXPORTER OF LATHES TO GERMANY

**GEDEE WEILER**

INNOVATE • TRANSFORM • INSPIRE

**GEDEE WEILER PRIVATE LIMITED**

Vellalore Road, Podanur P.O.

Coimbatore - 641 023, Tamil Nadu, INDIA.

EPABX: +91-422 2413908, 804 and 048

E: sales@gdweiler.com W: www.gdweiler.com

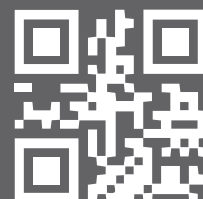

**HYDROSTATIC GUIDEWAYS MACHINES**

# Hydrostatic Guideways Machine from Ace Designers



HPT 180 HS

Source: Ace Micromatic Group

**H**ydrostatic Guideways Turning Centers make a big difference in achieving better surface finish, circularity, and GD&T. So far, no Indian machine tool manufacturer has ever built a turning machine with a Mineral Cast Bed and Hydrostatic Guideways. Ace Designers Ltd envisaged this product as an import substitute and worked towards building several technologies that culminated in this product HPT 180 HS.

**Features of the machine**

**Full Mineral Cast Bed** provides excellent vibration damping and noise reduction. It has low heat conductivity than cast iron. The thermal capacity of mineral cast is about two times greater than cast iron.

**In Hydrostatic Guideways**, there is no metal-to-metal contact between the slide and the guideway. The friction of hydrostatic guides is a power of ten lower and proportional to speed. In contrast to plain guides, hydrostatic

systems do not suffer from backlash when the direction of motion is reversed or the stick-slip effect. The guides are permanently play-free. Significantly higher level of positioning accuracy. Hydrostatic guides are more linear than the guide surfaces themselves.

**Highly Accurate Spindle**, which has a Thermo-symmetric structure. It is provided with P2 class (Grinding class) spindle bearings. The spindle is built-in with an oil-cooled headstock. A spindle assembly with air-purging. Other features include special low friction wipers, bellows with lamella for axes, linear glass scale for axes.

**Ace Micromatic Group**  
www.acemicromatic.net  
Hall & Stall: Hall 5,  
Ace Micromatic Group Pavillion

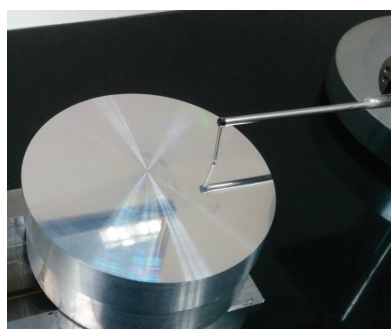

Soft Part Turning - Table 1

Source: Ace Micromatic Group Pavillion

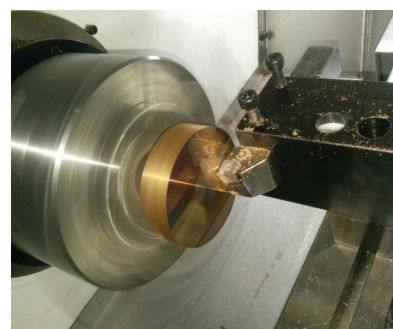

Soft Part Turning - Table 2

**LAUNCH - LASER MARKERS**

# Making a Mark



Source: Stamp 'It Robotai & Solutions Pvt Ltd

**S**tamp 'It Robotai & Solutions Pvt Ltd is launching its Laser Marker that has its own electronic cards and Stampsoft Software at IMTEX 2023 & Tooltech 2023. Laser marking technology is the preferred choice in manufacturing due to its intrinsic advantage; It is permanent and durable, and since it is a non-contact marking, is clean and dry. The speed of marking is very fast, making it a high-productivity machine. For

graphics and logos, the machine gives high resolution and good quality. It can also mark QR code, Barcode, and Data Matrix Code. It is a maintenance-free machine with no requirement for consumable parts on a regular basis. It is reliable and environment-friendly.

**SD**

**Stamp 'It Robotai & Solutions Pvt Ltd**  
www.marknstamp.com  
Hall & Stall: 2A/B-102

**LAUNCH - ROTARY TABLES AND GEAR HOBBING MACHINES**

# UCAM's Q Series and VAJRA-130



Source: UCAM Pvt Ltd

**U**CAM is introducing its new line of rotary tables, the 'Q Series', which includes the URQ-180, URQ-200, URQ-250, UDDRI-T300/60LP, USSR-200qTN, ULSR-200qTN, and UMTL-140mq. These tables are renowned for their exceptional precision and accuracy and come in a variety of sizes and configurations, including 4-axis and 5-axis options, to meet the specific needs of the company's customers. The Q series rotary tables are state-of-the-art and designed for precision and versatility, with a range of sizes and features to meet a wide range of applications.

UCAM is also launching the VAJRA-130, the latest version of its 7-axis CNC gear hobbing machine which exemplifies its commitment to producing high-quality, durable, and reliable machines. It is built with the finest materials and rigorously tested to withstand the demands of modern manufacturing. The VAJRA-130 is constructed with high rigidity and specifically designed to achieve high accuracy, high production output, and high speed.

**SD**

**UCAM Pvt Ltd**  
www.ucamind.com  
Hall & Stall: 1A/A-102

# Mastercam®



Because Time = Money,  
Choose your CAM Software wisely

Concurrent shows

**IMTEX 2023**  
International Machine Tool & Manufacturing Technology Exhibition

**Tooltech 2023**  
International Exhibition of Dies & Molds, Forming Tools, Machine Accessories, Robotics and CAD/CAM

**DIGITAL MANUFACTURING**  
International Exhibition on Digital Manufacturing Technology

Visit us at Booth C-122, Hall 4

SHAPING THE FUTURE  
OF MANUFACTURING™

[www.mastercamapac.com](http://www.mastercamapac.com)

**CNC GEAR HOBBING MACHINES**

# PMT Machines' Hobbing Solution

**P**MT Machines Ltd has introduced new CNC Gear Hobbing machines suitable for workpiece diameters of up to 250 mm. The machines are designed for Heavy-duty

Hobbing of medium-sized gears. The machines are extremely rigid. High productivity can be guaranteed with optimum cutting parameters.

The machine has a rigid bed construction with coolant circulation for thermal stability. The use of backlash-free Ball Screws and LM Guideways in the drives ensures the capability of the machine at high cutting parameters. The Hobbing machines can cut the workpiece up to 250 mm in diameter and 300 mm in width, assisted by a main drive with a power of 11 kW.

The Hob Arbor Clamping mechanism allows the operator to quickly change Hobs, which reduces the set-up time. Automatic Hob Head Swivel and Hob Shifting are controlled through the CNC program. In case of power failure, the safety retraction function gets active to avoid the collision of the tool with the workpiece. The machines have automatic swarf removal by a chip conveyor and a chip bin. Other optional features include Hob Arbors with diameters 22 mm, 27 mm, and 40 mm; Fume Extractor; and Automatic Job Loading System. These machines are further enhanced for productivity by adapting Industry 4.0, the latest automation,

which could be robotic, servo arm, or tailor-made.

PMT has wide experience in making workholding and fixtures with complete tooled-up solutions under one roof. It is also a manufacturer of a variety of machines apart from traditional Traub Single Spindle Cam Operated Automats, CNC Internal-Grinders, External Grinders, Surface Grinders, Double Column Heavy Duty VTLs, Special Machines, Big Part manufacturing for the Energy and Oil & Gas sectors.



**PMT Machines Ltd**  
www.pmtmachines.com  
Hall & Stall: 2A/B-112

Source: PMT Machines Ltd

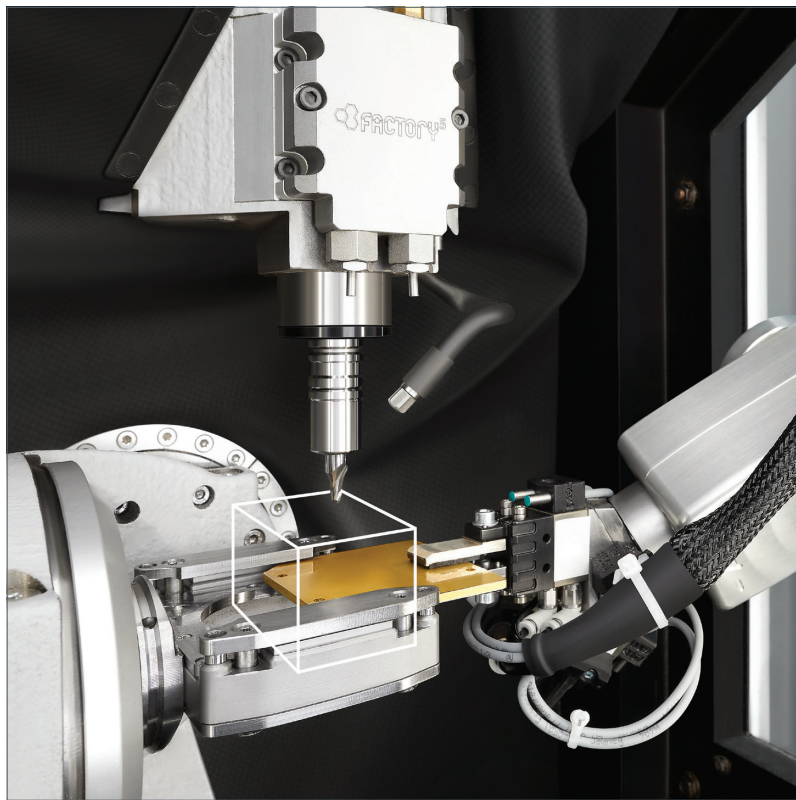

## CHIRON Group

### Process advantages

- 80,000 rpm spindle speed
- ± 2.5 µm precision
- 78 - 56 - 50 mm travel X - Y - Z max.
- 50 x 50 x 50 mm workpiece max.

Visit us at BIEC in Bengaluru from 19 - 25 January in Hall 4, Booth C113.



www.chiron-group.com

**COOLANT FILTRATION PRODUCTS**

# Cool Clean from U-Tech

**C**ool Clean is a range of coolant centrifuge units manufactured by U-tech Utpadan. These are mobile coolant centrifuges, hence can move from machine to machine. They are suitable for both coolant and straight-cutting oil. This is a media-less filtering device that does not consume paper. It filters the coolant down to 10 micron. Ideally suited for finishing operations like grinding, honing, etc., this centri-

fuge separates the fine dust by the centrifugal force generated inside the unit. These are available in manual, semi-automatic, and automatic models in various flow capacities. These products separate huge amounts of dust on a regular basis without the need of any filter media, which makes this a green product. The filtering device's capacity is of 50 LPM. The suction pump is a heavy-duty sludge pump of 1.7

kW, 50 LPM. It is equipped with a Transfer Pump of 0.2 kW, 50 LPM, a Delivery Pump of 0.2 kW, 50 LPM. Its Level Gauges are with Proximity Sensors. The Control Panel is with Contactor Logic. The Coolant Tank's Dirty Side is of 100 lt capacity and the Clean Side is of 100 lt.

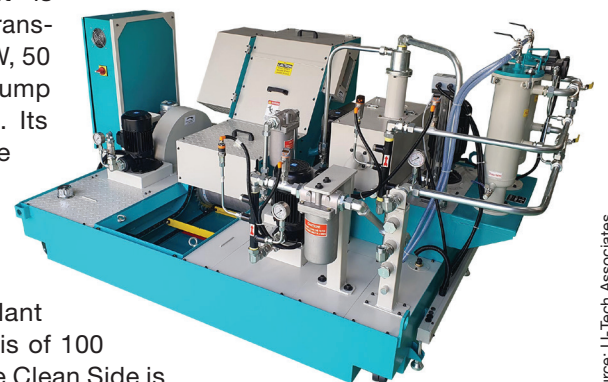

**U-Tech Associates**  
www.u-techindia.com  
Hall & Stall: 5/B-120

Source: U-Tech Associates

# MARPOSS



DIGITAL PLATFORM  
WELCOME FUTURE

VISIT US!



Booth B-101  
Hall No-3A

MARPOSS INDIA PVT. LTD.  
147, Sector 7, IMT Manesar 122 050 - Tel. +91 124 4735700 - sales@in.marposs.com

**PRESSURE MONITORING SYSTEMS**

## Next-Gen WPM for Gas Springs



Source: FIBRO India Precision Products Pvt Ltd

Fibro's system provides one with their production data globally if required and proactively notifies of pressure and temperature limits not being met.

By networking with other tools, machines and other objects, facilities are turned into an intelligent factory.

**What's new?**

The unique features of the system include: IoT gateway with cloud integration, Web-based user

interface, Internal storage of process data, and Proactive email function.

The system offers numerous advantages. Fibro's WPM system can be used to exploit the full potential for optimization in one's production facility. It reduces Gas Spring-specific downtimes as well as unplanned servicing and maintenance tasks. One can expect low investment costs with a short amortization period. **SD**

**MILLING CUTTERS**

## High-efficiency ALNEX Cutter Series



Source: Motherson Techno Tools (JV with Sumitomo Electric)

Motherson Techno Tools Ltd (MTTL) is a specialist in providing best-in-class integrated tooling and cutting solutions for all kinds of metal machining requirements. It is a joint venture between Sumitomo Electric Industries, Japan, and Motherson Group, India. The Automotive industry is increasingly striving to reduce the weight of individual engine components in order to improve fuel efficiency. This leads to the increasing use of non-ferrous materials such as aluminum alloys. To satisfy these market requirements, Sumitomo has developed a highly efficient PCD milling cutter ANX type for aluminum alloys.

- **Burr issue eliminated** – Unique edge design reduces the burr, thus eliminating any manual deburring or brush requirement.
- **Easy runout setting** – Axial run-out is easy and fast. Thanks to the simple and user-friendly design which enables fine adjustment of cutter runout in no time.
- **Light-weight body** – The use of an aluminum alloy body keeps the cutter weight at 1.0kg or less, even for  $\Phi 100$  mm cutters.

The series includes shank-type cutters in  $\phi 25, 30, 32, 40,$  and  $50$  mm as well as shell-type cutters with  $\phi 40, 50, 63, 80, 100, 125,$  and  $160$  mm and modular milling cutters in  $\phi 25, 30, 32,$  and  $40$  mm in different numbers of teeth with inch and metric mounting to choose from. **SD**

The advantages include:

- **Reduced milling time** – The feed rate is up to  $32,000$  mm/min, which is unmatched productivity.
- **Chip-Breaking redefined** – It's not just a through coolant cutter. Unique through insert coolant breaks the chips like none other.

**Motherson Techno Tools (JV with Sumitomo Electric)**  
www.mothersontools.com  
Hall & Stall: 4/B-143

**FIBRO India Precision Products Pvt Ltd**  
www.fibro-india.com  
Hall & Stall: 4/B-135

The patented cross-platform and cross-manufacturer Wireless Pressure Monitoring System (WPM) monitors the pressure and temperature of Gas Springs. The sensor system transmits the data via Bluetooth to a web-based gateway that establishes a connection to terminals either via WLAN or LAN. Specially developed software evaluates data for process control and preventive maintenance, thus increasing efficiency through early wear detection and needs-optimized maintenance intervals. The defined measures thus ensure error-free production.

**Would you like to be crowned a Productivity Champion ?**  
..... Share your success stories on **PRODUCTIVITY | TECHNOLOGY | INNOVATION....**

Win Cash Awards upto **₹10,00,000**

**IMTMA - ACE MICROMATIC Productivity Championship Awards 2023**  
"Showcasing Excellence in Manufacturing"

@  
**National Productivity Summit 2023**  
9 - 10 November 2023, Bangalore

**No Entry Fee | Multiple Entries Welcome !**

**Special stream for Micro & Small Enterprises**

**Productivity Champions of Yesteryears**

- Mahindra & Mahindra • Hero Motocorp • SKF • Maruti Suzuki • Tata Motors
- Bajaj Auto • TVS Motors • Bosch • Godrej • Toyota Kirloskar Auto Parts
- Titan Industries • UCAL Fuel Systems • ACE Designers • Delphi TVS • BHEL
- HAL • Tata Steel • BEL • INDO-MIM • Rane TRW • L&T MHPs
- Cummins • Adler Mediequip • Mekhos Technology and many more...

**Rush your entries by 30 April 2023**

Contact:  
**Abhishek** M: +91 9844294387 E: abhishek@imtma.in  
**Madan** M: +91 7899437625 E: madan@imtma.in

For more details logon to: [www.productivity.imtma.in](http://www.productivity.imtma.in)

ORGANISED BY  
Indian Machine Tool Manufacturers' Association

AWARDS SPONSOR  
**AceMicromatic Group**



## Meet companies from Bavaria

at IMTEX 2023 | booth B112 & B115 for latest technologies of machine tools "Made in Germany"

Especially here for you from Bavaria

**Eberle**  
| Made for more

**FLEXICAM**

**GMN**

**HAMUEL  
REICHENBACHER**  
Members of the SCHERDELgroup

**HUFSCHMIED**  
ZERSpanungSSYSTEME

**JAKOB**  
Antriebstechnik **JAKOB**

**mimatic**<sup>®</sup>  
Tool Systems  
Your Partner For Clever Tooling

**OPEN MIND**  
THE CAM FORCE

**OTT**  
Spanntechnik **JAKOB**

**Schwegler**

**WANDERER**  
www.wanderer-maschinen.de

[www.bayern-international.com](http://www.bayern-international.com)

**Bayern**  
International

**VDMA**

Regional Association  
Bavaria

Bavarian Ministry of Economic Affairs,  
Regional Development and Energy



**MANUFACTURING SOFTWARE**

## Mastercam Multiaxis for Improving Productivity

Mastercam Multiaxis is a specialized software solution designed to improve productivity through simultaneous 4- and 5-axis machining. It offers a range of advanced multi-axis machining strategies and is particularly useful for advanced control on 3-axis machines. With Mastercam Multiaxis, users have complete control over three essential elements of multi-axis machining: cut pattern, tool axis control, and collision avoidance.

This software delivers efficient multi-surface 5-axis roughing and finishing, including stock model awareness, and includes tilt axis limits to control the tool angle and prevent gouging or machine tool limit violations. It also features advanced gouge-checking and a 5-axis safe zone around the part to ensure safe cuts in even the most complex operations. Mastercam Multiaxis is compatible with several Mastercam products, including Mastercam Mill 3D, Mastercam Router 3D, Mastercam Mill-Turn, and Mastercam for SOLIDWORKS, to generate 5-axis code for virtually any CNC machine.

In addition to its advanced tool-path capabilities, Mastercam Multiaxis also offers support for advanced tool geometries as standard. It ensures accurate cuts and fast turnaround on even the toughest jobs, with streamlined multi-axis programming for maximum productivity. **SD**

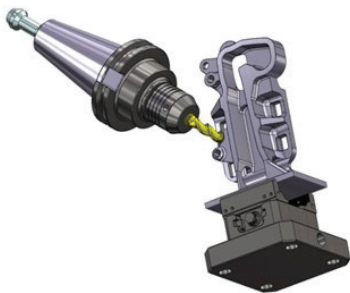

Source: Mastercam India

**Mastercam India**  
www.mastercamindia.com  
Hall & Stall: 4/C-122

**CNC TURNING/TURN-MILL CENTERS**

## AX 200 MY 625

AX 200 MY delivers productivity solutions with flexibility and precision. The machine meets the existing market demands and fulfills multi-tasking and precision turning/turn-mill operations to produce world-class products from simple turning and milling to complex multi-axis. The machine's main spindle is an electro-spindle for improving productivity in a single set-up. Most machines, available in the market with Y-Axis, have a virtual Y-Axis generated by synchronizing two axes. AX 200 MSY has an independent Y-Axis, which eliminates errors in the milling of intricate shapes. Independent Y-Axis makes programming easy and performs operations that are more accurate.

**Jyoti CNC Automation Ltd**  
www.jyoti.co.in  
Hall & Stall: 5/B-112



Source: Jyoti CNC Automation Ltd

A high-speed Servo Turret and Live Tool Servo Turret option give the flexibility to choose options from turning to turn-mill operations. Off-center machining with the Y-Axis and milling of angled surfaces with the C-Axis increases the range of machining. **SD**

**OPTICAL MEASURING MACHINES**

## ZEISS O-DETECT to Capture Things Easily

ZEISS O-DETECT is an optical measuring machine that offers intuitive operation, high-quality imaging, and flexible lighting for precise measurements in an instant. The technology is suitable for a wide variety of components but excels with those that are best left untouched.

**Key characteristics**

**Excellent optics:** The machine offers a large field of view at high resolutions. It offers increased efficiency and captures more details.

**Stable precision:** The calibration of the machine is in compliance with ISO 10360-7. It provides consistent and reliable measurement results one can trust.

**Versatility and ease of upgradation:** Options of classic multi-segment blue and white top light for general part top lighting are available. There is also the option of homogeneous dome light for lighting shiny workpieces. The option for Darkfield optimized lighting for challenging edges will also be available soon.

**Intuitive and user-friendly software:** The machine comes with ZEISS CALYPSO software. Beginners can use ZEISS CALYPSO express, which is easy to learn and program.



Source: Carl Zeiss India (Bangalore) Pvt Ltd

**Carl Zeiss India (Bangalore) Pvt Ltd**  
www.zeiss.com/metrology  
www.zeiss.co.in  
Hall & Stall: 2B/A-101

**Simple part navigation and visualization:** The integrated 5MP over-view color camera locates the part quickly to start measurements. Since it is controlled by the software, there is less need to use the joystick.

**Fields of application**

The industries where it finds applications include Electronics, Casting, Industrial Job Shop, Stamping, Medical, and Automotive.

The parts where it can be used include 3D workpieces (one side), Small parts, Turned parts, and Flat parts. **SD**

## Making Engineers Industry Ready

### Career oriented courses for Engineers

- Hands-on Training on Machine Tool Design - CNC GPM / SPM (Duration 8 Weeks)
- Finishing School in Production Engineering (Duration 6 Weeks)
- Hands-on Training on Industrial and Machine Automation for Digital Manufacturing (Duration 6 Weeks)
- Product Optimization through Finite Element Methods (FEM) (Duration 6 Weeks)
- Master class in Implementing Industry 4.0 in Manufacturing – A Hands-on approach (Duration 4 Weeks)

**Whom it is applicable**

- Fresh engineers seeking a career in manufacturing industry
- Engineering students in Pre final / final year
- New hires in industry
- Engineering students looking for internship

**Placement Assistance Provided**

**1,36,070+**  
Mandays

**2190+**  
Training Programmes

**40,145+**  
Professionals Trained

**6,200+**  
Companies Trained Pan India

For further details and registration, please contact:

Ph : +91 7349067391 / +91 9743180085  
E - Mail : training@imtma.in  
www.imtmatraining.com  
www.imtmaelearn.in





**TUBULAR LINEAR MOTORS**

# For High-Precision Applications



**D**esigned for high-precision machine tool applications, ANCA Motion's LinX® S-Series is a 3-phase brushless Tubular Linear Motor that provides improved performance at a lower running cost when compared to conventional Ball screw actuators, pneumatic and flatbed linear motors.

The motor consists of a shaft containing strong magnets and a forcer containing wound copper coils.

### LinX® tubular design

LinX®'s tubular design and the strong circular magnetic flux allow the LinX® motors to deliver superior efficiency. This is possible because the motor can fully utilize the magnetic flux generated by the magnetic shaft. Additionally, the symmetric design results in zero attractive forces between the forcer and shaft, significantly reducing the loading requirement on support bearings.

Owing to its tubular design, a water-cooling jacket can be applied onto the forcer which allows the motor's heat to be removed completely from the machine. This standalone thermal stability eliminates the requirement for a dedicated chiller, resulting in a smaller machine footprint.

Additionally, the compact profile of the LinX® S-Series allows machine manufacturers to significantly simplify installation because it can fit into a similar space as would a regular ball-screw and circular motor. This

allows integration into machine tools with minimal floor space use. Other advantages such as, reduced maintenance, and extended machine life are a result of no physical contact between the shaft and the forcer. ANCA Motion has been able to seal the LinX® S-Series Motor to IP67.

### Smoother finish on tools ground with LinX® powered machines

The ironless core of the LinX® Motors and even force over the entire stroke bring out unprecedented motion performance, and because of its direct drive nature, the motor can track motion commands more accurately and repetitively to achieve a much better surface finish on tools ground by a LinX® powered machine. With no downforce, no cogging, and no backlash, the LinX® S-Series motor produces truly amazing machine performance. **SD**

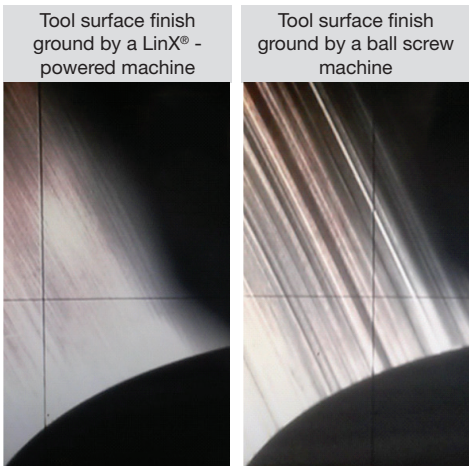

**ANCA Motion**  
www.ancamotion.com  
Hall & Stall: 4/A-155

**TWIN SPINDLE TURNING MACHINES**

# Twin Spindle CNC Chucker MW80G

**M**uratec MW80G is a compact twin spindle turning machine with a Gang tooling (Linear) concept. The machine offers high precision with direct spindle drive and construction. MW80 is suitable for hard part turning with short cycle times.

This small machine comes with a 6 in. chuck and can accommodate up to 4 gang tools. MW80 has a Spindle power of 7.5 kW and speeds up to 6000 RPM are available. It can turn parts up to 80 mm in diameter and lengths of up to 50 mm.

Linear Tooling eliminates turret Indexing time for significant cycle time reduction. The loader is available with swivel or horizontal types.

With standard loading/unloading time as low as 3 sec, MW80 is an optimal solution for high-speed turning and for simple parts such as small bearings, rings, gears and hard part turning. The most widely used applications are Bearing Outer and Inner, Differential Pinion and Side Gear, Compressor Wheel, etc. The machine can be supplied with either single or twin gantry loaders. Muratec is a global leader in providing fully integrated built-in automation for a variety of applications. **SD**



**Meiban Engineering Technologies Pvt Ltd**  
www.meibanengg.com  
Hall & Stall: 5/B-103

Source: Meiban Engineering Technologies Pvt Ltd

January 19th- 25th, 2023  
BIEC, Bengaluru  
HALL No. 2B STALL No. A101B

Quality Since 1890

**HOME OF CLAMPING**

**ECONOMICAL, PRECISE, QUICK**  
- THE AMF ZERO-POINT SYSTEM

By using modern AMF zero-point systems, optimize fixture and workpiece changeover in production, correspondingly reduce set-up times on the machine and so save money!

The benefits of zero-point clamping technology are obvious:

- > Increase in machine run-time
- > Very fast workpiece or fixture changeover
- > High repeatability
- > A uniform interface for all machines
- > Positioning and clamping in a single step

Numerous advantages speak for themselves and make the AMF zero-point system a technology that revolutionizes the zero-point clamping market.

**ANDREAS MAIER Workholding Technology Pvt. Ltd.**  
(Subsidiary of : AMF - GERMANY)  
# 116, 2nd Cross, NHCS Layout, Basaveshwaranagar, BENGALURU-560079, INDIA  
Phone: +91 80 2323 8444 E-mail: amfindia@amf.de Web: www.amf.de



## Forming the Future of Manufacturing

Asia's Largest Exhibition on Metal Forming and Manufacturing Technologies

# IMTEX FORMING 2024

International Forming Technology Exhibition

Concurrent shows



In association with



**19 - 23 January 2024**

Bangalore International Exhibition Centre (BIEC), Bengaluru

Organiser



Venue



[www.imtex.in](http://www.imtex.in)

## MARKING & CLEANING TOOLS

### Marking & Cleaning Tool by AMF

AMF Markers are tools that can be used for the permanent marking of workpieces on CNC milling as well as turn-mill machines. With its special needle, marking can be achieved without the appearance of any cutting edges. The marking is accomplished through a combination of material compression and displacement. The tool can be used with or without machine spindle rotation. Moreover, marking is possible on smooth, uneven, and rough surfaces with a deviation between 3 and 7 mm.

The tool is infinitely adjustable for use on different materials, surface hardness, and depth of marking. If used on 45 HRC hardened steel, the effective tool life will be equivalent to a marking distance of 70 km. High-speed marking is also possible. The

needles are highly wear-resistance. Additionally, it is suitable for marking thin-walled workpieces and round surfaces (up to 15 degree). Depending on the design, it is possible to mark surfaces with a hardness of up to 57 HRC.

AMF Cleaners are tools for cleaning workpieces, tools, and the interior of CNC machines. They are preferably clamped in Weldon chucks and mounted in the machine spindle of a CNC machine.

AMF Cleaners in Stick design are available in lengths of 30, 100 and 180 mm and are ideally suitable for cleaning swarf from workpieces, vices, and fixtures prior to unloading the workpieces and before the next workpieces are loaded. AMF Cleaners in the Ball design are available with horizontal or vertical connection to the machine spindle and are designed for cleaning the entire interior working area of the machine tool.

SD

**ANDREAS MAIER Workholding Technology Pvt Ltd**  
[www.amf.de](http://www.amf.de)  
Hall & Stall: 2B/A101-B



Source: ANDREAS MAIER Workholding Technology Pvt Ltd

## 3D SCANNERS

### Big Idea in a Small Package

A powerful 3D Scanner, GOM Scan 1 features a compact shape and robust design filled with advanced technologies. From GOM's Blue Light Technology to the stereo camera principle, this sensor is built to deliver 3D data with high precision.

**Small, mobile, and super easy to use:** The light-weight solution allows one to capture 3D data intuitively. Easy to operate, GOM Scan 1 is the specialist for simple and fast measurements of small- to medium-sized parts, even in confined spaces.

**Fast and precise:** GOM Scan 1, with pre-installed GOM Inspect, takes meshes to the next level. One can rely on high-quality data, generate precise meshes, and get 3D data easily and fast.

**For accurate measurements:** GOM Scan 1, with GOM Inspect, is a system to support one's entire workflow. It helps to get accurate and comprehensive measurement results and makes part inspection effortless. One can import and align CAD and mesh files, create surface comparisons and inspection sections, and generate reports easily and efficiently.



Source: APM Technologies 3D Pvt Ltd

### Printing with intelligent mesh editing:

GOM Inspect lets one smooth, thin, and refine polygon meshes, fill holes or extract curvature lines, achieving very accurate meshes that can be saved in many common formats. The best part is smart polygonization. It creates a mesh with the highest detail while keeping the mesh size easy to handle.

The New GOM Scan 1 is ideal for 3D printing, Reverse engineering and manufacturing, Virtual display or 3D models, Research and education, Art and heritage, Design, and Healthcare.

SD

**APM Technologies 3D Pvt Ltd**  
[www.apmtech.in](http://www.apmtech.in)  
Hall & Stall: 2B/A-111



# Achieve Top-notch Production with Smart Machinery

Smart Managements

Smart Machines

## 5 AXIS MACHINING CENTER



▶ DCV 2018A



▶ TCV 3000A



▶ UV 650



▶ NFX 400A

## VMC

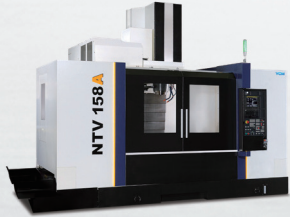

▶ NTV 158A



▶ TV 188B



▶ i5



▶ DV 30T

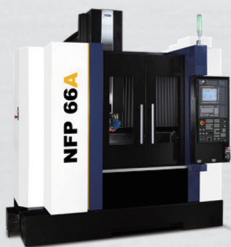

▶ NFP 66A



▶ NSV 106A



▶ NDC 3018B



▶ NMV 106A

## CNC LATHE



▶ GT - 250MA



▶ NTC-2000LSY



▶ NH 500A

## HMC



Corporate Office

**S&T ENGINEERS (P) LTD.**

22, Vasanth Nagar, Singanallur,  
Coimbatore - 641 005, Tamil Nadu, India.

+91-422-2590810, 2591470, 2593487

+91 73970 37333 info@stengineers.com

www.stengineers.com



STALL : A113 - Hall 1A

DATE : 19<sup>th</sup> - 25<sup>th</sup> Jan - 2023

TIME : 10.00 am - 6.00 pm



**MAKING TECHNOLOGY AFFORDABLE**



# STLR 400

## HIGH PRODUCTIVE INDUSTRIAL GRADE 3D METAL PRINTERS



**A technology platform built to drive Digital Transformation in manufacturing, leading to increased productivity & profits**



AN INVITATION TO CELEBRATE THE  
**50<sup>th</sup>** ANNIVERSARY  
OF MGT



Visit us at  
**Hall 5, AceMicromatic Group Pavilion**